

## N-Channel Enhancement Mode MOSFET

### Features

- 30V/8A ,  $R_{DS(ON)}=15m\Omega(\text{typ.}) @ V_{GS}=10V$   
 $R_{DS(ON)}=23m\Omega(\text{typ.}) @ V_{GS}=4.5V$
- Super High Dense Cell Design for Extremely Low  $R_{DS(ON)}$
- Reliable and Rugged
- SO-8 Package

### Pin Description

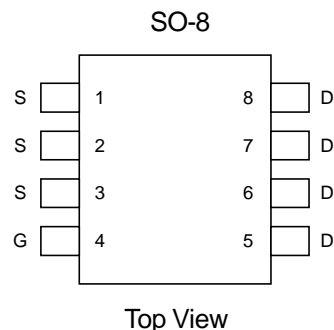

### Applications

- Power Management in Notebook Computer , Portable Equipment and Battery Powered Systems.

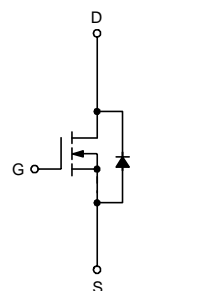

N-Channel MOSFET

### Ordering and Marking Information

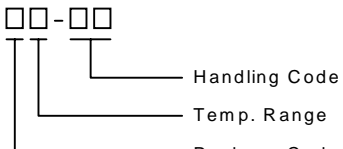
<p>APM9410 □□-□□</p> 	<p>Package Code K : SO-8</p> <p>Operating Junction Temp. Range C : -55 to 150°C</p> <p>Handling Code TU : Tube TR : Tape &amp; Reel</p>
<p>APM9410 K : <span style="border: 1px solid black; padding: 2px;">APM9410 XXXXX</span></p>	<p>XXXXXX - Date Code</p>

### Absolute Maximum Ratings ( $T_A = 25^\circ\text{C}$ unless otherwise noted)

Symbol	Parameter	Rating	Unit
$V_{DSS}$	Drain-Source Voltage	30	V
$V_{GSS}$	Gate-Source Voltage	$\pm 20$	
$I_D^*$	Maximum Drain Current – Continuous	8	A
$I_{DM}$	Maximum Drain Current – Pulsed	32	

\* Surface Mounted on FR4 Board,  $t \leq 10$  sec.

ANPEC reserves the right to make changes to improve reliability or manufacturability without notice, and advise customers to obtain the latest version of relevant information to verify before placing orders.

**Absolute Maximum Ratings (Cont.)** ( $T_A = 25^\circ\text{C}$  unless otherwise noted)

Symbol	Parameter	Rating	Unit	
$P_D$	Maximum Power Dissipation	$T_A=25^\circ\text{C}$	2.5	W
		$T_A=100^\circ\text{C}$	1.0	W
$T_J$	Maximum Junction Temperature	150	$^\circ\text{C}$	
$T_{\text{STG}}$	Storage Temperature Range	-55 to 150	$^\circ\text{C}$	
$R_{\theta JA}$	Thermal Resistance – Junction to Ambient	50	$^\circ\text{C/W}$	

**Electrical Characteristics** ( $T_A = 25^\circ\text{C}$  unless otherwise noted)

Symbol	Parameter	Test Condition	APM9410			Unit
			Min.	Typ.	Max.	
<b>Static</b>						
$BV_{\text{DSS}}$	Drain-Source Breakdown Voltage	$V_{\text{GS}}=0\text{V}$ , $I_{\text{DS}}=250\mu\text{A}$	30			V
$I_{\text{DSS}}$	Zero Gate Voltage Drain Current	$V_{\text{DS}}=24\text{V}$ , $V_{\text{GS}}=0\text{V}$			1	$\mu\text{A}$
		$V_{\text{DS}}=24\text{V}$ , $V_{\text{GS}}=0\text{V}$ , $T_f=55^\circ\text{C}$			5	
$V_{\text{GS(th)}}$	Gate Threshold Voltage	$V_{\text{DS}}=V_{\text{GS}}$ , $I_{\text{DS}}=250\mu\text{A}$	1	1.5	2	V
$I_{\text{GSS}}$	Gate Leakage Current	$V_{\text{GS}}=\pm 20\text{V}$ , $V_{\text{DS}}=0\text{V}$			$\pm 100$	nA
$R_{\text{DS(ON)}}^a$	Drain-Source On-state Resistance	$V_{\text{GS}}=10\text{V}$ , $I_{\text{DS}}=4\text{A}$		15	20	m $\Omega$
		$V_{\text{GS}}=4.5\text{V}$ , $I_{\text{DS}}=2\text{A}$		23	32	
$V_{\text{SD}}^a$	Diode Forward Voltage	$I_{\text{SD}}=2\text{A}$ , $V_{\text{GS}}=0\text{V}$		0.7	1.3	V
<b>Dynamic<sup>b</sup></b>						
$Q_g$	Total Gate Charge	$V_{\text{DS}}=15\text{V}$ , $I_{\text{DS}}=10\text{A}$ $V_{\text{GS}}=5\text{V}$ ,		15	20	nC
$Q_{\text{gs}}$	Gate-Source Charge			5.8		
$Q_{\text{gd}}$	Gate-Drain Charge			3.8		
$t_{\text{d(ON)}}$	Turn-on Delay Time	$V_{\text{DD}}=15\text{V}$ , $I_{\text{DS}}=2\text{A}$ , $V_{\text{GEN}}=10\text{V}$ , $R_G=6\Omega$		11	18	ns
$T_r$	Turn-on Rise Time			17	26	
$t_{\text{d(OFF)}}$	Turn-off Delay Time			37	54	
$T_f$	Turn-off Fall Time			20	30	
$C_{\text{iss}}$	Input Capacitance	$V_{\text{GS}}=0\text{V}$		1200		pF
$C_{\text{oss}}$	Output Capacitance	$V_{\text{DS}}=15\text{V}$		220		
$C_{\text{riss}}$	Reverse Transfer Capacitance	Frequency=1.0MHz		100		

## Notes

<sup>a</sup> : Pulse test ; pulse width  $\leq 300\mu\text{s}$ , duty cycle  $\leq 2\%$

<sup>b</sup> : Guaranteed by design, not subject to production testing

## Typical Characteristics

Output Characteristics

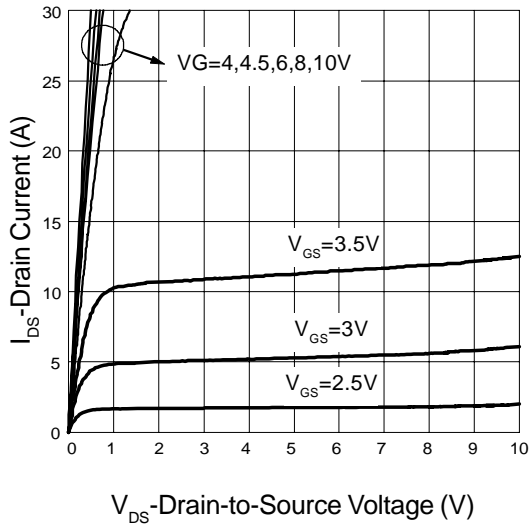

Transfer Characteristics

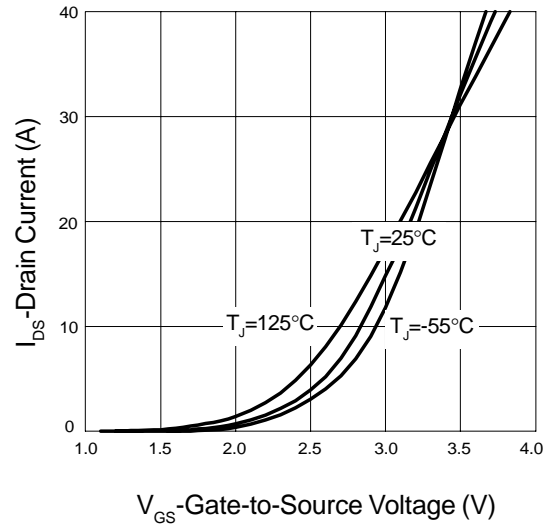

Threshold Voltage vs. Junction Temperature

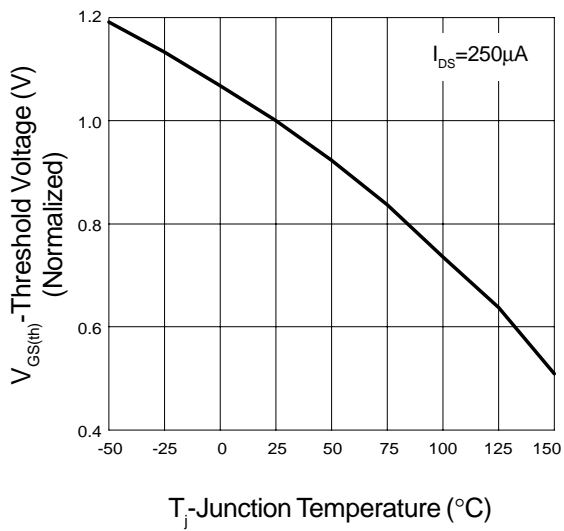

On-Resistance vs. Drain Current

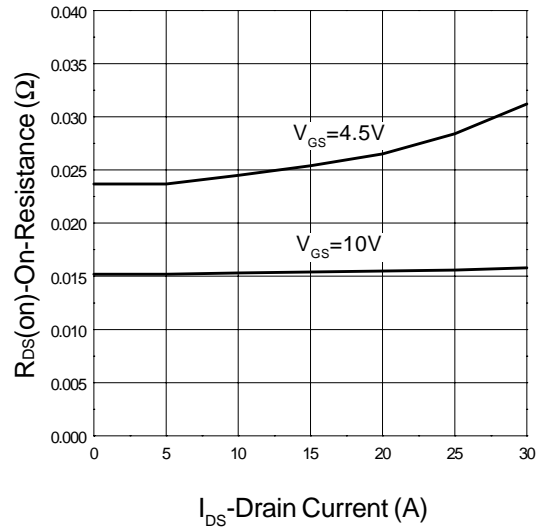

Typical Characteristics (Cont.)

On-Resistance vs. Gate-to-Source Voltage

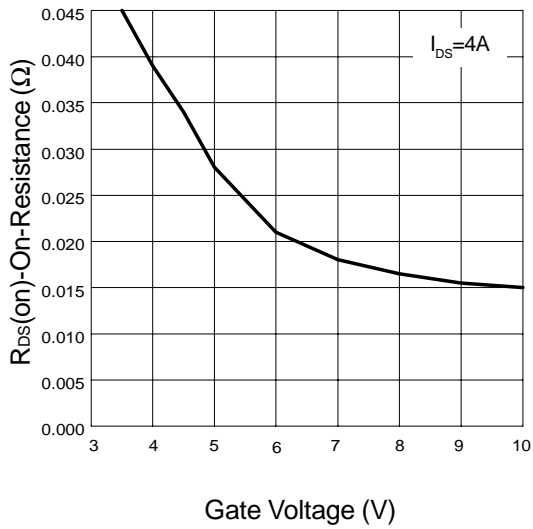

On-Resistance vs. Junction Temperature

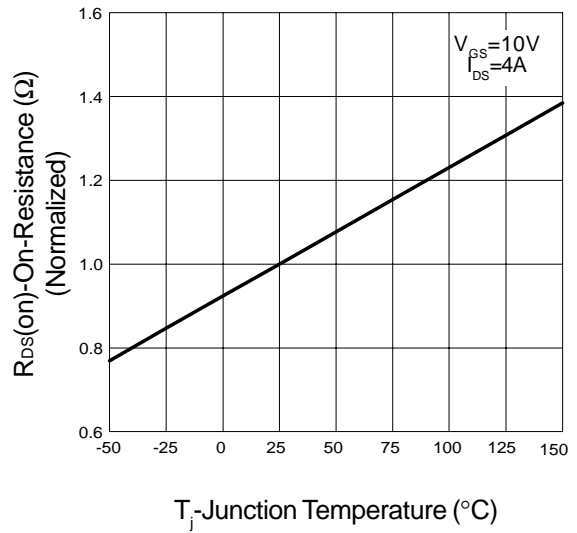

Gate Charge

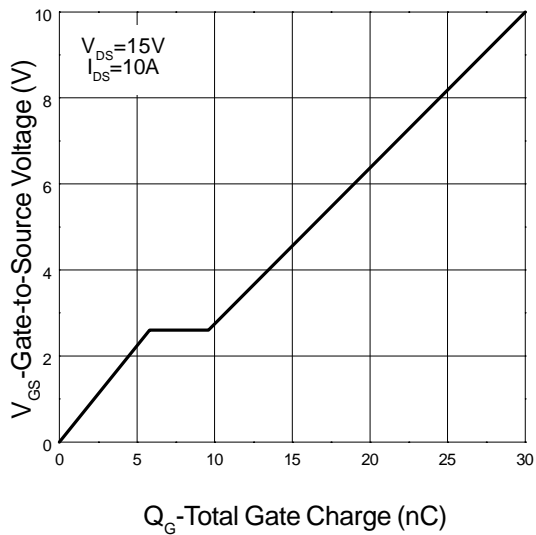

Capacitance Characteristics

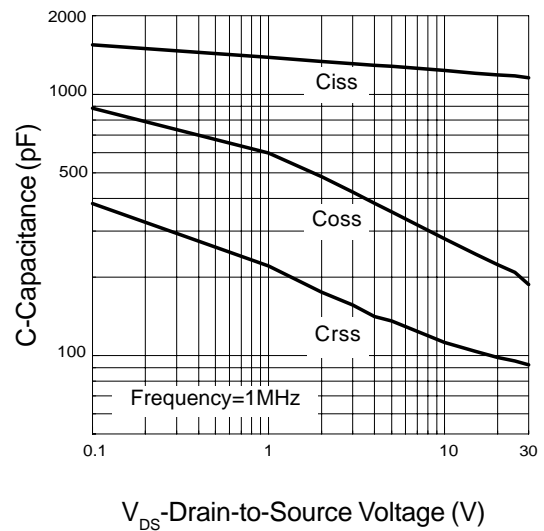

Typical Characteristics (Cont.)

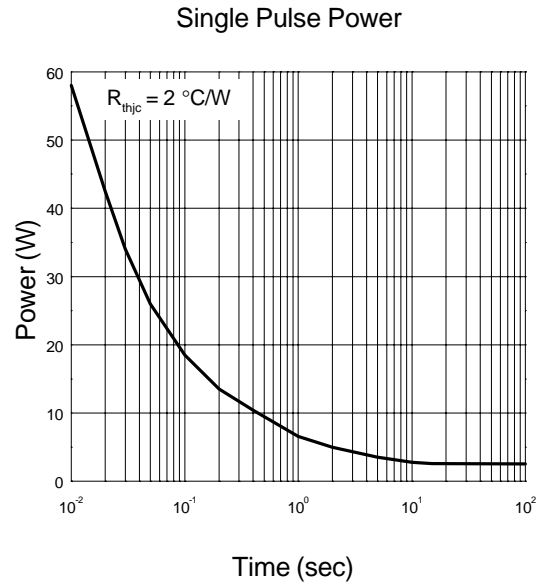
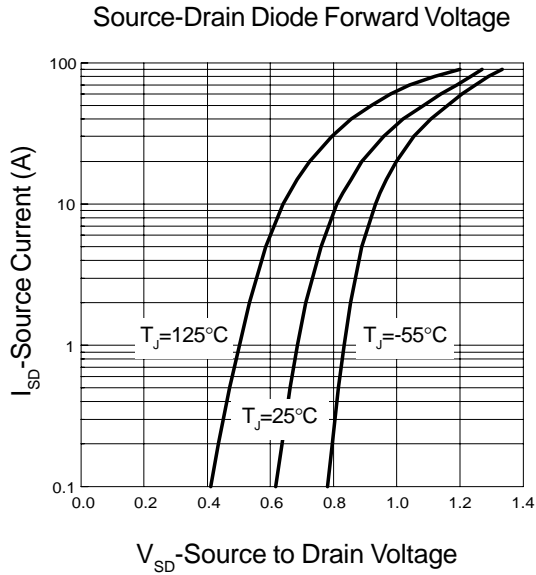

Normalized Transient Thermal Impedance, Junction to Ambient

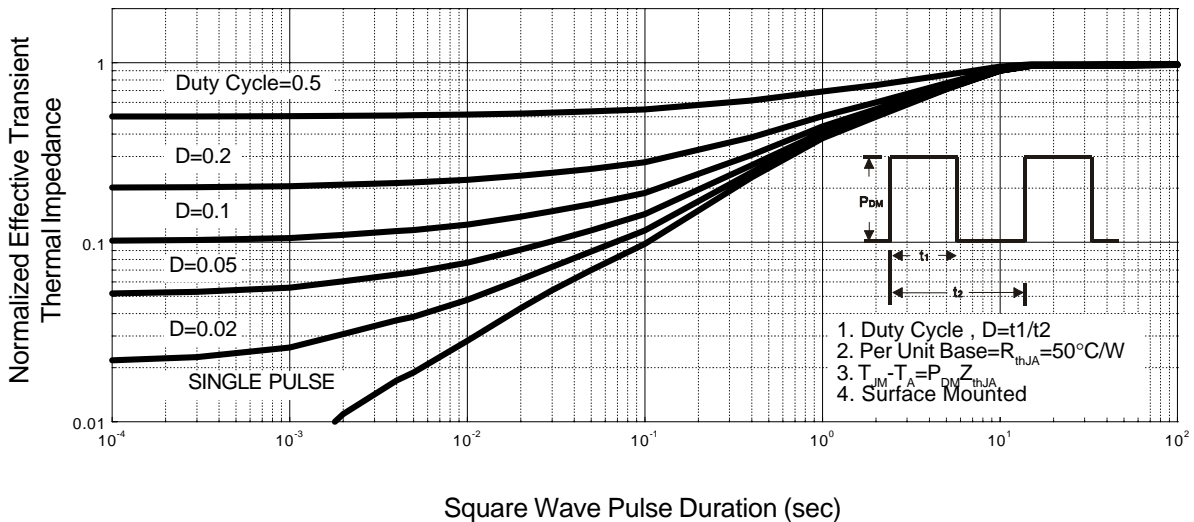

## Packaging Information

SOP-8 pin ( Reference JEDEC Registration MS-012)

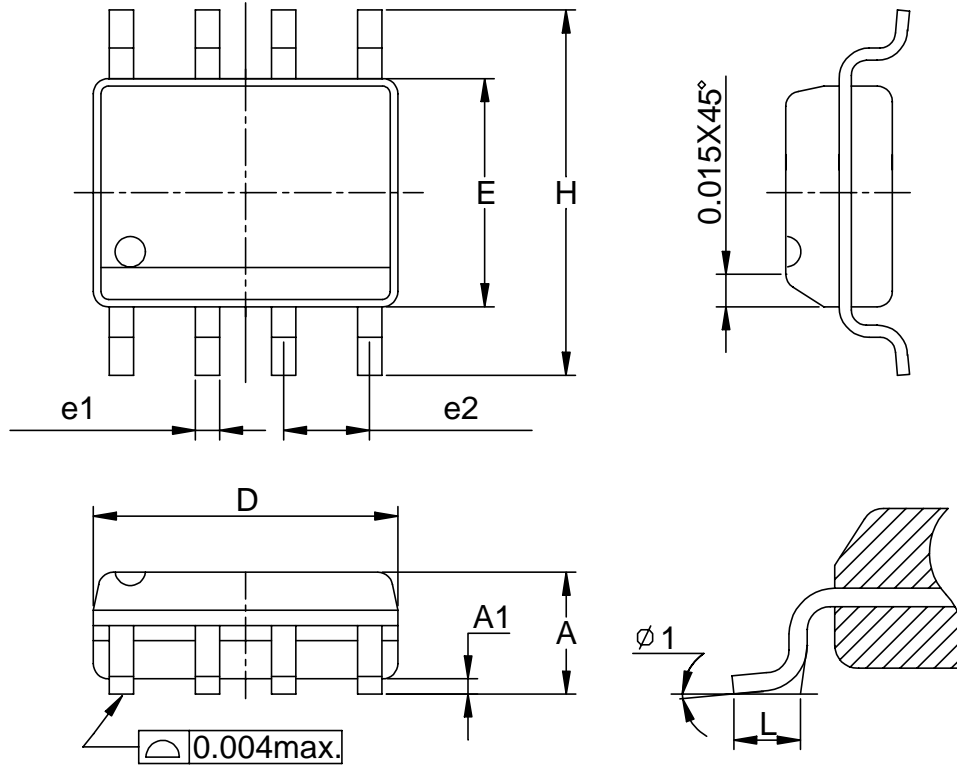

Dim	Millimeters		Inches	
	Min.	Max.	Min.	Max.
A	1.35	1.75	0.053	0.069
A1	0.10	0.25	0.004	0.010
D	4.80	5.00	0.189	0.197
E	3.80	4.00	0.150	0.157
H	5.80	6.20	0.228	0.244
L	0.40	1.27	0.016	0.050
e1	0.33	0.51	0.013	0.020
e2	1.27BSC		0.50BSC	
φ 1	8°		8°	

## Physical Specifications

Terminal Material	Solder-Plated Copper (Solder Material : 90/10 or 63/37 SnPb)
Lead Solderability	Meets EIA Specification RSI86-91, ANSI/J-STD-002 Category 3.

## Reflow Condition (IR/Convection or VPR Reflow)

Reference JEDEC Standard J-STD-020A APRIL 1999

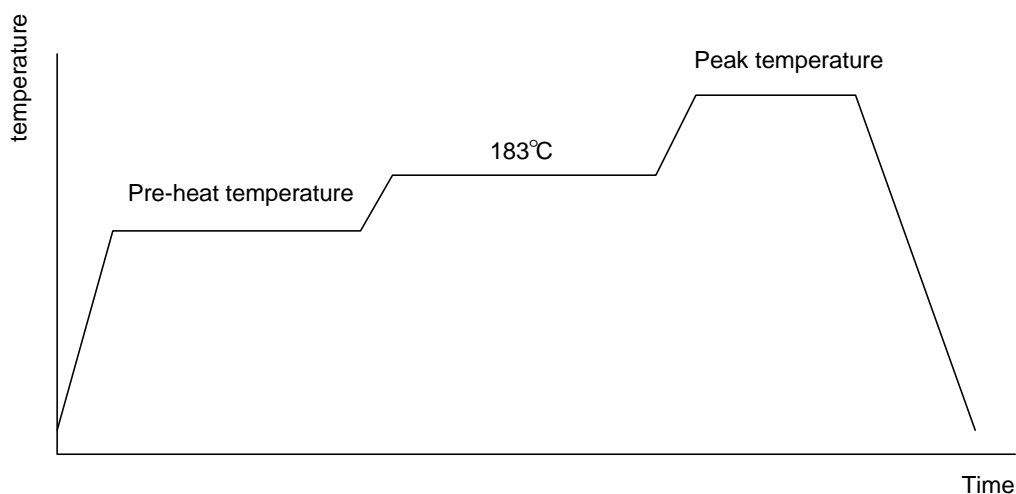

## Classification Reflow Profiles

	Convection or IR/ Convection	VPR
Average ramp-up rate(183°C to Peak)	3°C/second max.	10 °C /second max.
Preheat temperature 125 ± 25°C)	120 seconds max	
Temperature maintained above 183°C	60 – 150 seconds	
Time within 5°C of actual peak temperature	10 –20 seconds	60 seconds
Peak temperature range	220 +5/-0°C or 235 +5/-0°C	215-219°C or 235 +5/-0°C
Ramp-down rate	6 °C /second max.	10 °C /second max.
Time 25°C to peak temperature	6 minutes max.	

## Package Reflow Conditions

pkg. thickness ≥ 2.5mm and all bgas	pkg. thickness < 2.5mm and pkg. volume ≥ 350 mm <sup>3</sup>	pkg. thickness < 2.5mm and pkg. volume < 350mm <sup>3</sup>
Convection 220 +5/-0 °C		Convection 235 +5/-0 °C
VPR 215-219 °C		VPR 235 +5/-0 °C
IR/Convection 220 +5/-0 °C		IR/Convection 235 +5/-0 °C

## Reliability test program

Test item	Method	Description
SOLDERABILITY	MIL-STD-883D-2003	245°C, 5 SEC
HOLT	MIL-STD 883D-1005.7	1000 Hrs Bias @ 125°C
PCT	JESD-22-B, A102	168 Hrs, 100% RH, 121°C
TST	MIL-STD 883D-1011.9	-65°C ~ 150°C, 200 Cycles

## Carrier Tape & Reel Dimensions

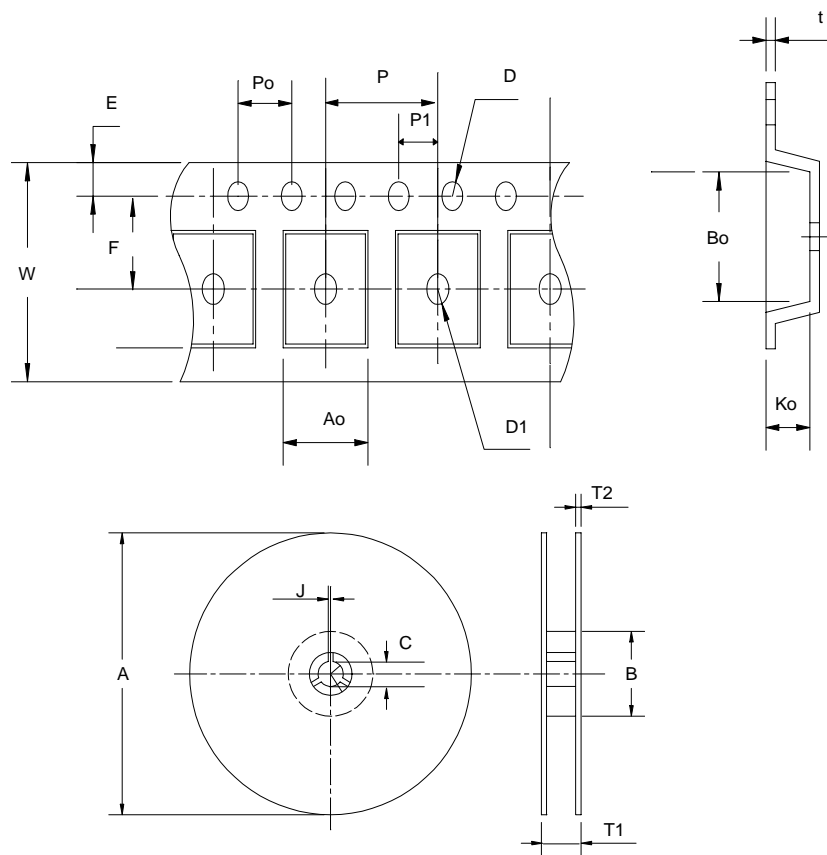

Application	A	B	C	J	T1	T2	W	P	E
SOP-8	$330 \pm 1$	$62 +1.5$	$12.75 + 0.15$	$2 \pm 0.5$	$12.4 \pm 0.2$	$2 \pm 0.2$	$12 \pm 0.3$	$8 \pm 0.1$	$1.75 \pm 0.1$
	F	D	D1	Po	P1	Ao	Bo	Ko	t
	$5.5 \pm 1$	$1.55 + 0.1$	$1.55 + 0.25$	$4.0 \pm 0.1$	$2.0 \pm 0.1$	$6.4 \pm 0.1$	$5.2 \pm 0.1$	$2.1 \pm 0.1$	$0.3 \pm 0.013$



## Cover Tape Dimensions

Application	Carrier Width	Cover Tape Width	Devices Per Reel
SOP- 8	12	9.3	2500

## Customer Service

### Anpec Electronics Corp.

Head Office :

5F, No. 2 Li-Hsin Road, SBIP,

Hsin-Chu, Taiwan, R.O.C.

Tel : 886-3-5642000

Fax : 886-3-5642050

Taipei Branch :

7F, No. 137, Lane 235, Pac Chiao Rd.,

Hsin Tien City, Taipei Hsien, Taiwan, R. O. C.

Tel : 886-2-89191368

Fax : 886-2-89191369